

	PROPRIETARY ITEM - EXCEPT FOR USES EXPRESSLY PERMITTED IN WRITING BY SOUTHCO, INC. ALL RIGHTS ARE RESERVED BY SOUTHCO, INC.		CONCEALED DOOR STAY HINGE TRADE DRAWING		DATE: 14DEC2000	DRAWN: RJB	CHKD: NTS	SCALE: NTS	DRAWING NUMBER: J-R6-22-1
	REV. DATE	DRAWN	REVISION	COMPONENT	MATERIAL	FINISH/COLOR	SEE NOTE A SEE NOTE A SEE NOTE A	SEE NOTE A SEE NOTE A SEE NOTE A	MILLIMETER DIMENSIONS DIMENSIONS WITHOUT TOLERANCES ARE FOR REFERENCE ONLY.
			ROLLER LEAF CAM LEAF RIVET (2) WASHER BUSHING (2)	300 SERIES STAINLESS STEEL ACETAL ACETAL	NATURAL BLACK BLACK				

DRAWING NUMBER
J-R6-22-1

NOTE A: PART NUMBER MATERIAL & FINISH

R6-22-11 STEEL, ZINC PLATE
R6-22-23 300 SERIES STAINLESS STEEL, NATURAL

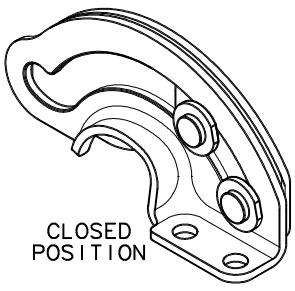
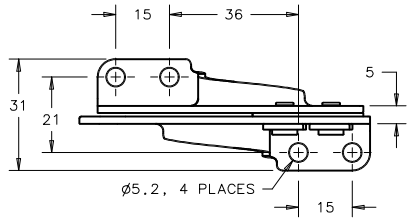

CLOSED POSITION

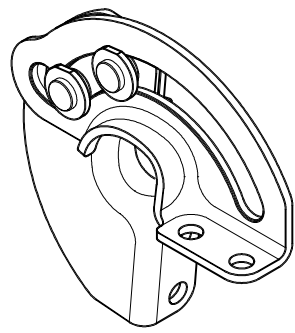

OPEN POSITION

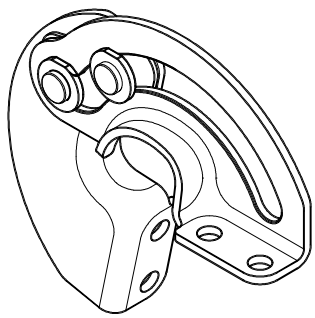

STAY OPEN POSITION

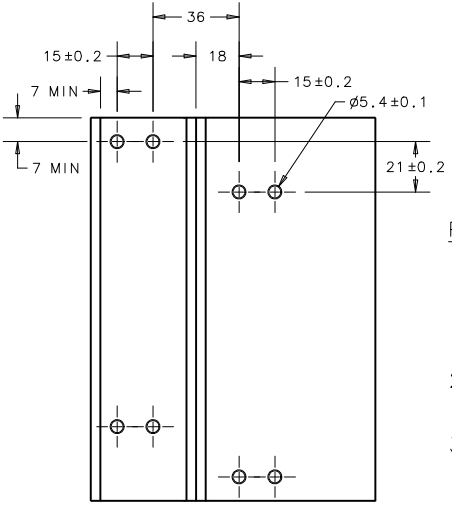
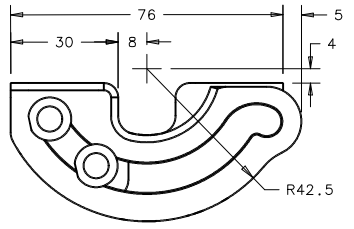
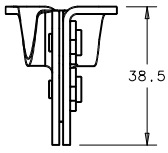

PANEL PREPARATIONS

1. MAX PANEL THICKNESS 4mm UNLESS CHAMFERED 45° AS SHOWN ON FAR RIGHT.
2. PREPARE DOOR AND FRAME AS SHOWN.
3. INSTALL USING M5 OR No. 10 HARDWARE (NOT SUPPLIED) OR BY WELDING.

