

NOTES:

- A. MATERIAL AND FINISH:  
 HOUSING: DIE CAST ZINC, CHROME PLATED  
 LOCK PLUG BODY: DIE CAST ZINC, ORGANIC COATING (IF ASSEMBLY INCLUDES SCALP) OR CHROME PLATED  
 LOCK WAFERS AND SPRINGS: STAINLESS STEEL OR BRASS, NATURAL  
 PAWL AND ACTUATOR: DIE CAST ZINC, ORGANIC COATING  
 KEYS: NICKEL PLATED BRASS
- B. HOUSING COSMETIC SPECIFICATION:  
 TOP SURFACE OF HOUSING IS TO BE A CLASS "B" SURFACE, AND ALL OTHER SURFACES ARE TO BE CLASS "C" PER SOUTHCO COSMETIC SPECIFICATION S-121-01 FOR CHROME PLATING.
- C. PK-50-01-01 IS PROVIDED WITH NO LOCK PLUG. LOCK PLUG IS ORDERED SEPARATELY.
- D. KEY CODES LS001 - LS125 USE MASTER KEY, SOUTHCO PART NUMBER PK-24-01.
- E. DIN LOCK CAN BE USED WITH SOUTHCO H3 OR M3-40 SERIES LATCHES.

**southco**

PROPRIETARY ITEM - EXCEPT FOR USES EXPRESSLY GRANTED IN WRITING INFORMATION DISCLOSED HEREON IS CONFIDENTIAL AND ALL RIGHTS PATENT AND OTHERWISE ARE RESERVED BY SOUTHCO, INC.

DIN LOCK ASSEMBLY  
 FIXED CAM - TYPE B

DATE	DRAWN	CHKD	SCALE	DRAWING NUMBER
27JUL2005	RSN		1:1	J-PK-50

REV	DATE	DRAWN/CHKD	DESCRIPTION	PART NUMBER	MATERIAL AND FINISH	KEY CODE
I	18JUN2012	MJS/LCR	PRN: P2012-0738	PK-50-XX-0Y	SEE NOTE A	CH751
J	15OCT2018	CMS/CTG	PRN: P2018-2385	PK-50-XX-0Y-ZZZ	SEE NOTE A	SEE KEY CODE OPTION TABLE

**MILLIMETERS**

ALL DIMENSIONS WITHOUT TOLERANCES ARE FOR REFERENCE ONLY.

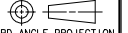

THIRD ANGLE PROJECTION

A3 PAPER SIZE

KEY CODE OPTIONS:

- ZZZ - KEY CODE
- 001 - LS001
  - 002 - LS002
  - 003 - LS003
- ↓ ↓
- 050 - LS050 (SEE NOTE D)
- ↓ ↓
- RS001 - RS001
- ↓ ↓
- RS050 - RS050
- KD1010 - KEYED DIFFERENTLY, 10 DIFFERENT KEY CODES, RS001 - RS010, SOLD IN BAGS OF 10.
- KD1050 - KEYED DIFFERENTLY, 50 DIFFERENT KEY CODES, RS001 - RS050, SOLD IN BAGS OF 50.
- KD1125 - KEYED DIFFERENTLY, 125 DIFFERENT KEY CODES, RS001 - RS125, SOLD IN BAGS OF 125.
- MK1010 - MASTER KEYED, KEYED DIFFERENTLY, 10 DIFFERENT KEY CODES, LS001 - LS010, SOLD IN BAGS OF 10.
- MK1050 - MASTER KEYED, KEYED DIFFERENTLY, 50 DIFFERENT KEY CODES, LS001 - LS050, SOLD IN BAGS OF 50.
- MK1125 - MASTER KEYED, KEYED DIFFERENTLY, 125 DIFFERENT KEY CODES, LS001 - LS125, SOLD IN BAGS OF 125.

PART NUMBER:

PK-50-XX-0Y-[ZZZ]

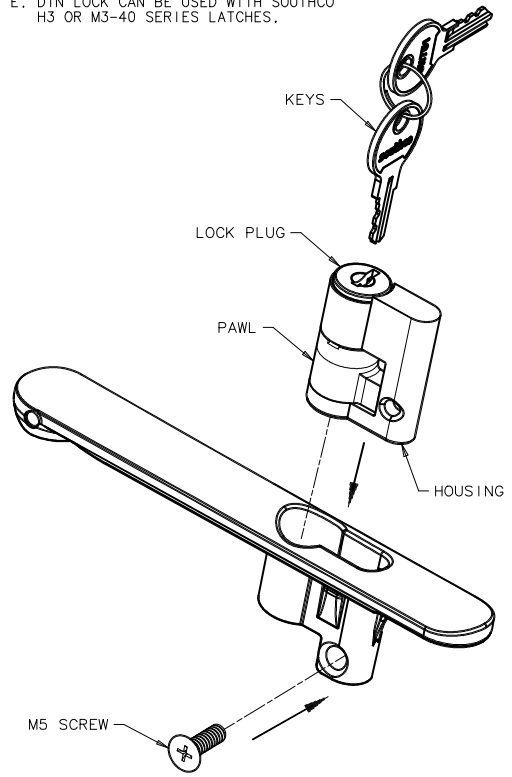
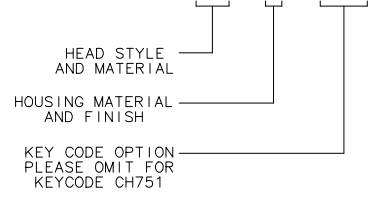

INSTALLATION  
 SCALE 3:4

INSTALLATION INSTRUCTIONS:

- ALIGN LOCK ASSEMBLY WITH SLOT IN MATING PART AS SHOWN.
- PUSH LOCK ASSEMBLY INTO MATING PART UNTIL MOUNTING HOLES ALIGN.
- SECURE LOCK ASSEMBLY INTO MATING PART USING A M5 FLATHEAD SCREW.

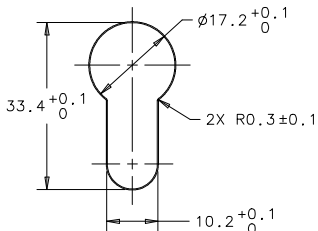

HOLE PREPARATION

HEAD STYLE OPTIONS:

- XX - HEAD STYLE
- 01 - NO LOCK PLUG
  - 02 - KEY LOCKING, DIE CAST ZINC, CHROME PLATED, NO SHUTTER
  - 05 - KEY LOCKING, DIE CAST ZINC, STAINLESS STEEL SCALP, DROP SHUTTER
  - 10 - KEY LOCKING, DIE CAST ZINC, STAINLESS STEEL SCALP, SLIDE SHUTTER

HOUSING OPTIONS:

- Y - HOUSING MATERIAL AND FINISH:
- 1 - DIE CAST ZINC, CHROME PLATED

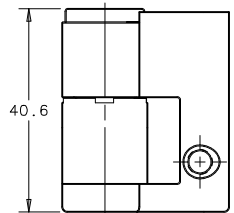
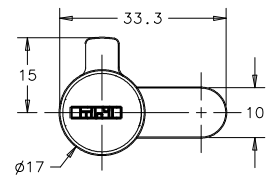

PK-50-05-0Y-ZZZ  
 PK-50-10-0Y-ZZZ

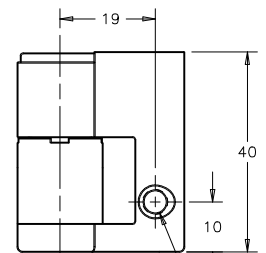

M5 X 0.8 THRU  
 PK-50-02-0Y-[ZZZ]

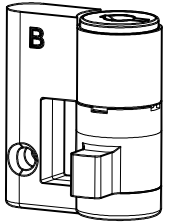
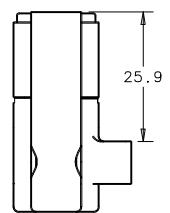

ASSEMBLED (SHOWN IN LOCKED POSITION)