

RECOMMENDED
INSTALLATION
TOOLING

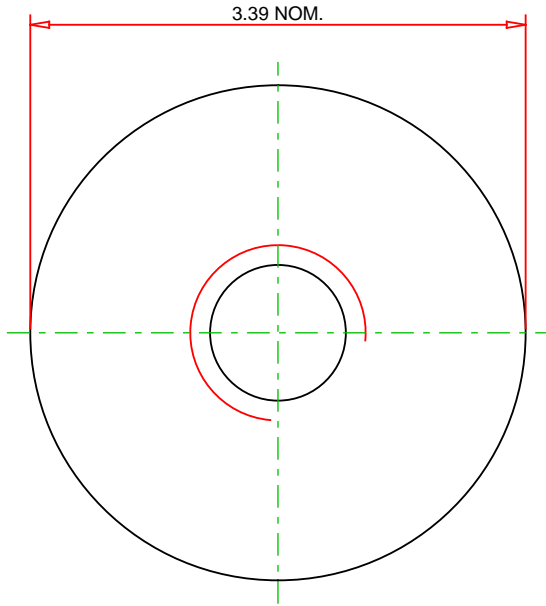

RECOMMENDED INSTALLATION ANVIL

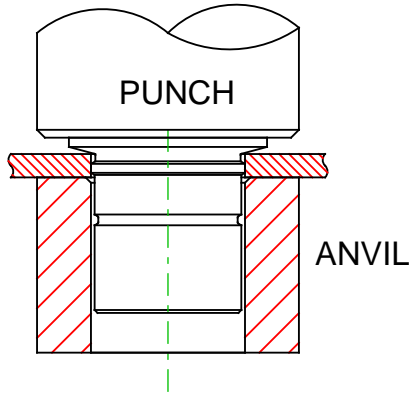
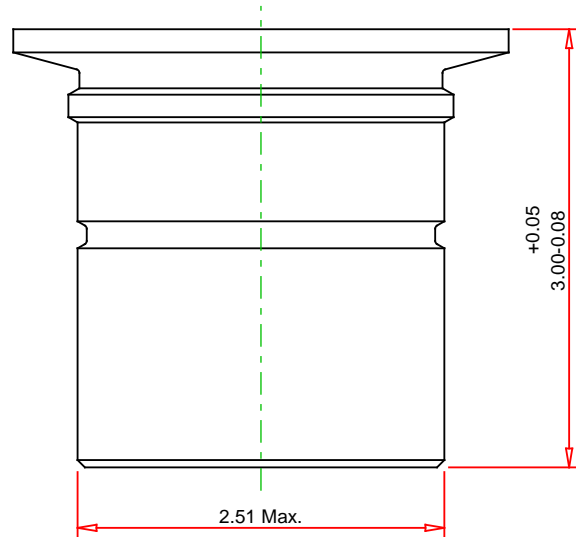
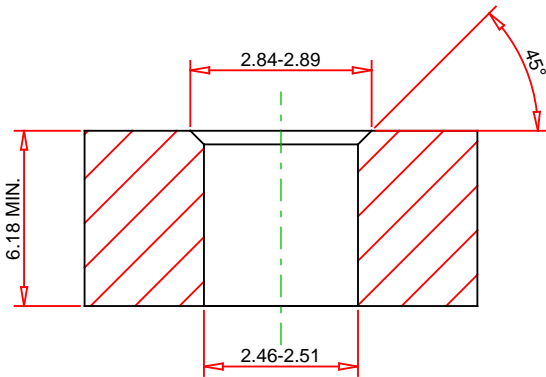

© 2024 PennEngineering

ALL DIMENSIONS IN MILLIMETERS

DATE 25-JUN-2024

NOTE : DRAWING NOT TO SCALE

THREAD :	M1.2 x 0.25	MOUNTING HOLE DIA. :	2.59 +0.05
MATERIAL:	HARDENED 400 SERIES STAINLESS STEEL	PANEL THICKNESS:	0.2 MINIMUM
HEAT TREAT:	YES	MAX. PANEL HARDNESS:	HRC 37 / HB 340
FINISH:	Passivated and/or tested per ASTM A380	MIN CENTERLINE-TO-EDGE:	2.85

DESCRIPTION :
PEM® TYPE TMSO4™ SELF-CLINCHING MICRO STANDOFFS
METRIC

PART NO. :
TMSO4-M1.2-300



PennEngineering®

EMAIL: TECHSUPPORT@PEMNET.COM
WWW.PEMNET.COM