

HAEGER® Part Number	
Anvil	H-186-04/M6L
Punch	H-185-04/M6L

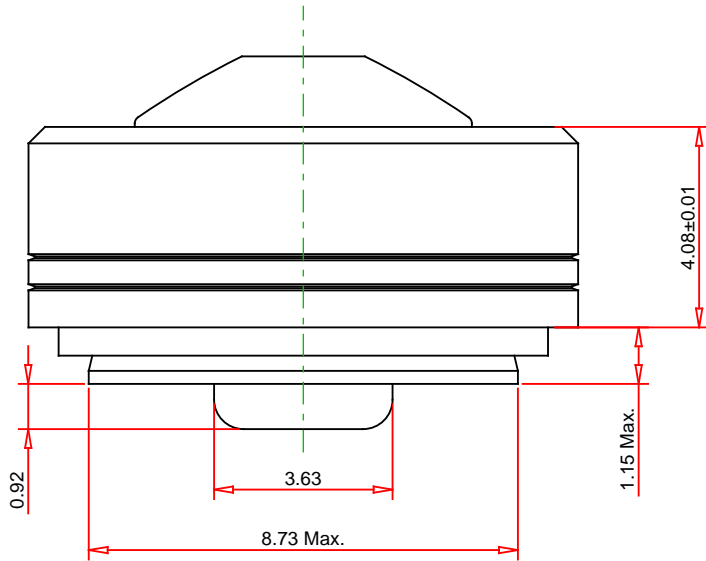

© 2024 PennEngineering

ALL DIMENSIONS IN MILLIMETERS

DATE 16-APR-2024

NOTE : DRAWING NOT TO SCALE

THREAD : M6 x 1	MOUNTING HOLE DIA. : 8.75 +0.08 -0.00
MATERIAL: 300 Series Stainless Steel	PANEL THICKNESS: 1.2 MINIMUM
HEAT TREAT: NONE	MAX. PANEL HARDNESS: HRB 70 / HB 125
FINISH: Passivated and/or tested per ASTM A380	MIN CENTERLINE-TO-EDGE: 8.6

DESCRIPTION :
 PEM® PreTect™ Thread Masking Plugs



PennEngineering®

PART NO. :
 CLS-M6-0-TP

EMAIL: TECHSUPPORT@PEMNET.COM
 WWW.PEMNET.COM